

# Chapter 8 Parts Lists And Drawings

No.01	Head And Spindle Shaft Assembly. . . . .	15
No.02	Motor Assembly. . . . .	17
No.03	Feed Handle Assembly . . . . .	19
No.04	Rotary Support Assembly . . . . .	21
No.05	Vise Assembly . . . . .	23
No.06	Table Assembly . . . . .	25
No.07	Safety Guard Assembly. . . . .	27
No.08	Main Base Assembly. . . . .	29
No.09	Small Base Assembly . . . . .	31
No.10	Electric Circuit . . . . .	33

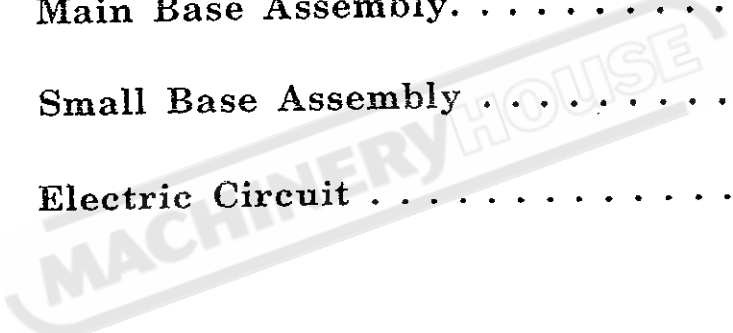

NO.	PART NO.	MAT.NO.	DESCRIPTION	QTY.	SPECIFICATION	NO.	PART NO.	MAT.NO.	DESCRIPTION	QTY.	SPECIFICATION
1	13A011		HEAD STOCK	1	FC25	25	M3C004		SPACER	1	SS41
2	13A010		COVER	1	SS41	26	M3C007		THRUST BEARING	1	E30305J
3	13C010		WORM WHEEL	1	ALBC3	27	M3C005		COVER	1	SS41
4				1	SS41	28	F06D016		SCREW	4	M6XP1.0X16
5	VG0023		BEARING	1	E30309J	29	M3C011		HELICAL GEAR	1	S45C
6	ZQ0065		OIL SEAL	1	55X72X9 TC	30	M0C034		CHECK NUT	1	S45C
7	13A014		BEARING COVER	1	S45C	31	13A004		ADJUSTABLE NUT	1	SS41
8	F06D016		SCREW	3	M6XP1.0X16	32	F10F060		SCREW	1	M10XP1.0X60
9	ZV0029		KEY	1	8X7X28	33	13A006		ARM	1	SS41
10	13C01204		SPINDLE SHAFT	1	SCM21	34	13A008		SPRING	1	SUP6
11	H0C012		PIN	2	D10XL28	35	R10		SPRING WASHER	1	M10
12	H0C001		BLADE COVER	1	S45C	36	F10F025		SCREW	2	M10XP1.5X25
13	Q10		FLAT WASHER	1	M10	37	G08E025		SCREW	2	M8XP1.25X25
14	F10G035		SCREW	1	M10XP1.5X35(1.25)	38	M08E		HEX NUT	2	M8
15	VG0030		BEARING	1	E32207J	39	M3C009		OUTER TOOTH WASHER	1	AW05
16	H0C006		HEX NUT	1	M30XP1.5	40	M3C010		CHECK NUT	1	AN05
17	C155		OUTER TOOTH WASHER	1	M30	41	VF0018		NEEDLE BEARING	1	TLA 253226
18	13A013		COVER	1	SS41	42	F04B012		SCREW	3	M4-12
19	F06D016		SCREW	3	M6XP1.0X16	43	ZK0165		CHECK NUT	1	YSF M40XP1.5
20	IK0031		SIGHT GLASS	1	21mm	44	I3C01400		SPACER	1	SS41
21	ZE0010		DRAIN PLUG	1	PT3/8"XL12,PLUG	45					
22						46					
23	13C011		WORM SHAFT	1	SNCM220	47					
24	M3C008		THRUST BEARING	1	E30205J	48					

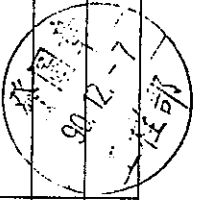

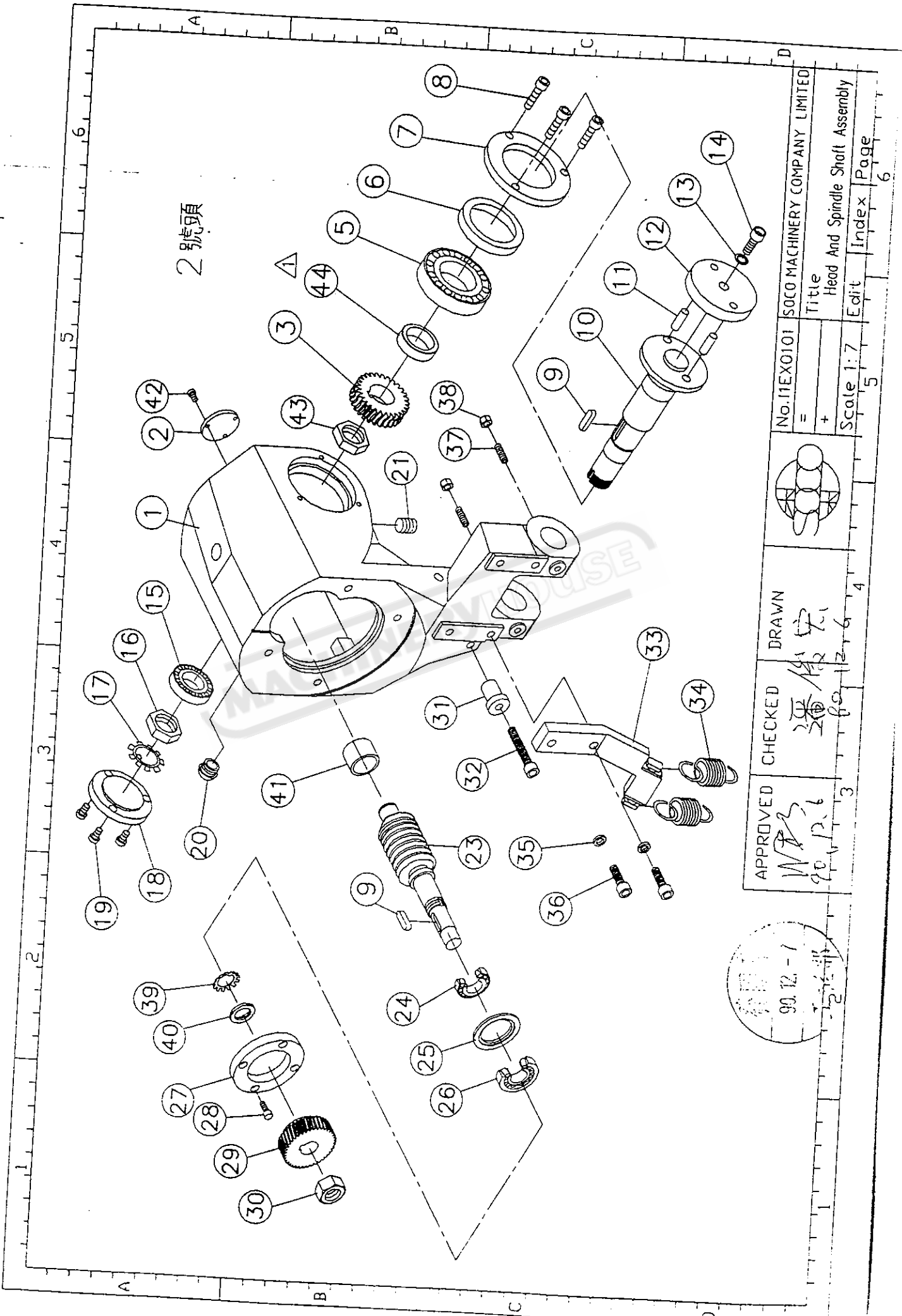

APPROVED	CHECKED	DRAWN	No.11EX0101	SOCO MACHINERY COMPANY LIMITED
WFS	20/12/6	20/12/6	=	Title
20/12/6	20/12/6	20/12/6	+	Head And Spindle Shaft Assembly
3	4	4	Scale 1:7	Edit
			5	Index
				Page
				6

90.12-1

2012.12.6

NO.	PART NO.	MAT.NO.	DESCRIPTION	QT.	SPECIFICATION	NO.	PART NO.	MAT.NO.	DESCRIPTION	QT.	SPECIFICATION
1	I3B002		MOTOR ASSEMBLY	1	3/1.5HP 2/4 P	25					
2	H0G001		MOTOR ELECTRIC BOX	1	SS4I	26					
3	ZR0020		CLAMPER	1	7C	27					
4	H0G002		FIXING PLATE	1	SPCC	28					
5	XC0066		TERMINAL BOARD	1	6P20A	29					
6	B04B006		SCREW	4	M4xP0.7x6	30					
7	F06D025		SCREW	2	M6xP1.0x25	31					
8	H0G003		COVER	1	SS4I	32					
9	B06D020		SCREW	4	M6xP1.0x20	33					
10	R06		SPRING WASHER	4	M6	34					
11	WS0031		MULTI SPEED	1	SC6848(20A)	35					
12	ZR0019		CLAMPER	1	4C	36					
13	ZV0040		KEY	1	6x6x30	37					
14	I3C009		HELICAL GEAR	1	SNCM22	38					
15	B15		OUTER TOOTH WASHER	1	M20	39					
16	M20F		HEX NUT	1	M20XP1.5	40					
17						41					
18						42					
19						43					
20						44					
21						45					
22						46					
23						47					
24						48					

06

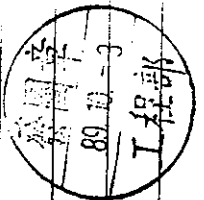

FOR HEAD NO.2

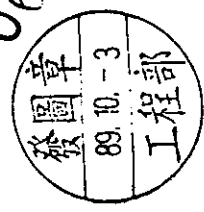
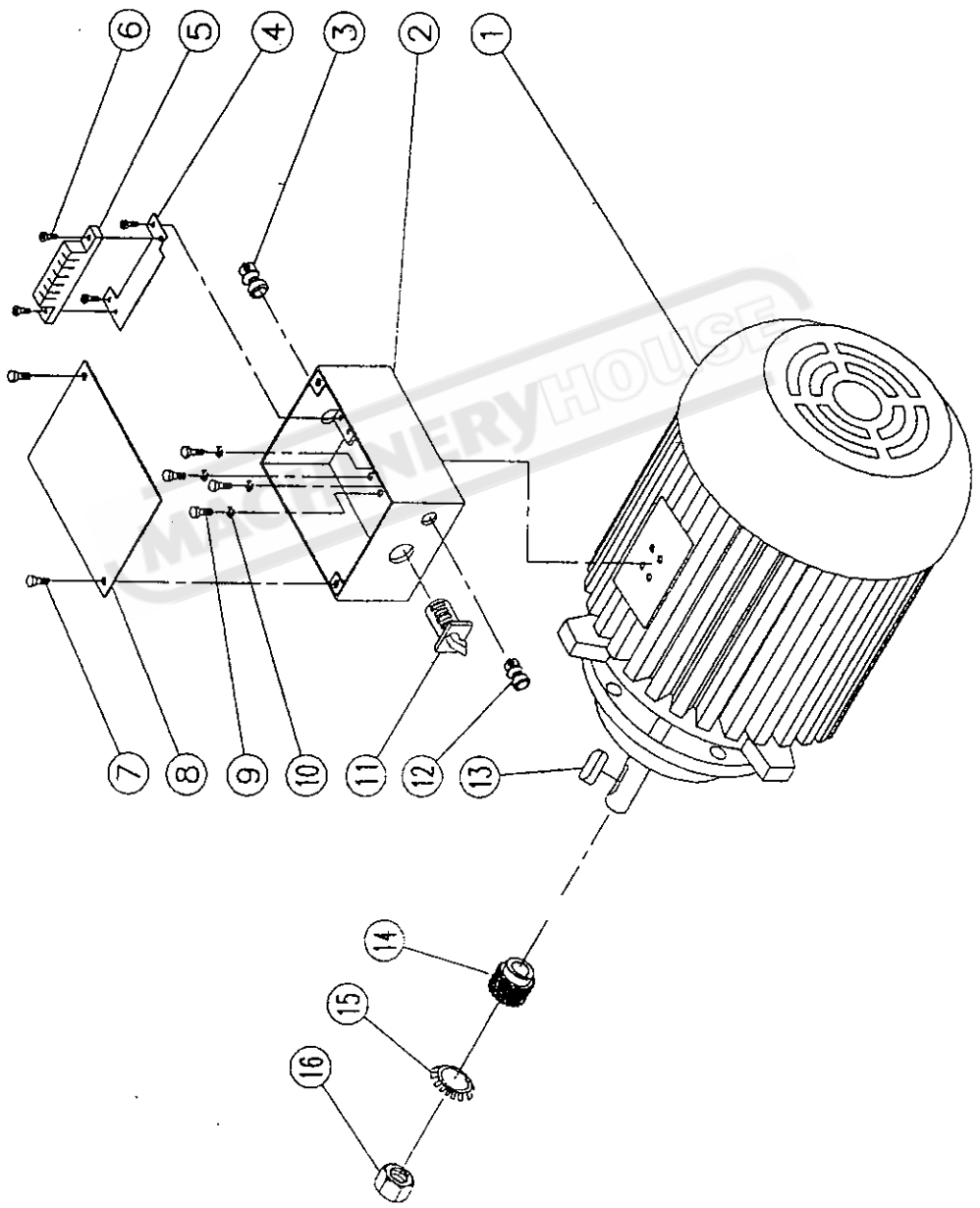

APPROVED	CHECKED	DRAWN	No. 11EX0200	SOCO MACHINERY COMPANY LIMITED		
				Title		
89.10.13	[Signature]	[Signature]	=	Motor Assembly		
				Scale 1:11		
1	2	3	4	5	6	6

No.	PART NO.	MAT.NO.	DESCRIPTION	QT.	SPECIFICATION	NO.	PART NO.	MAT.NO.	DESCRIPTION	QT.	SPECIFICATION
1	XA0061		CABLE	1	4CX0.75MM	25					
2	XE0010		RUBBER SLEEVE	1	SMALL	26					
3	B04B028		SCREW	4	M4XP0.7X28	27					
4	H0A003		FEED LEVER KNOB	1	PLASTIC(ABS)	28					
5	B04B028		SCREW	1	M4XP0.7X28	29					
6	H0A004		RUBBER SHIELD	1	RUBBER	30					
7	H0A028		ELECTRIC SWITCH	1	SS41	31					
8	H0A006		FEED LEVER KNOB	1	PLASTIC(ABS)	32					
9	M04C		HEX NUT	5	M4XP0.7	33					
10	H0A007		FEED LEVER	1	SS41	34					
11	M20K		HEX NUT	1	M20XP2.5	35					
12	I3A003		PIVOT SHAFT	2	S45C	36					
13	I3A005		JUNK RING	2	SS41	37					
14	I3A009		SPLASH SHIELD	1	PLASTIC	38					
15	M30F		CHECK NUT	2	M30XP1.5	39					
16	Q08		WASHER	2	M8	40					
17	C08E012		SCREW	1	M8XP1.25X12	41					
18						42					
19						43					
20						44					
21						45					
22						46					
23						47					
24						48					

06

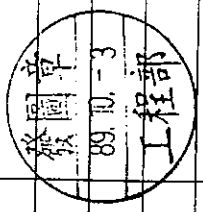

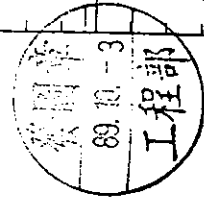
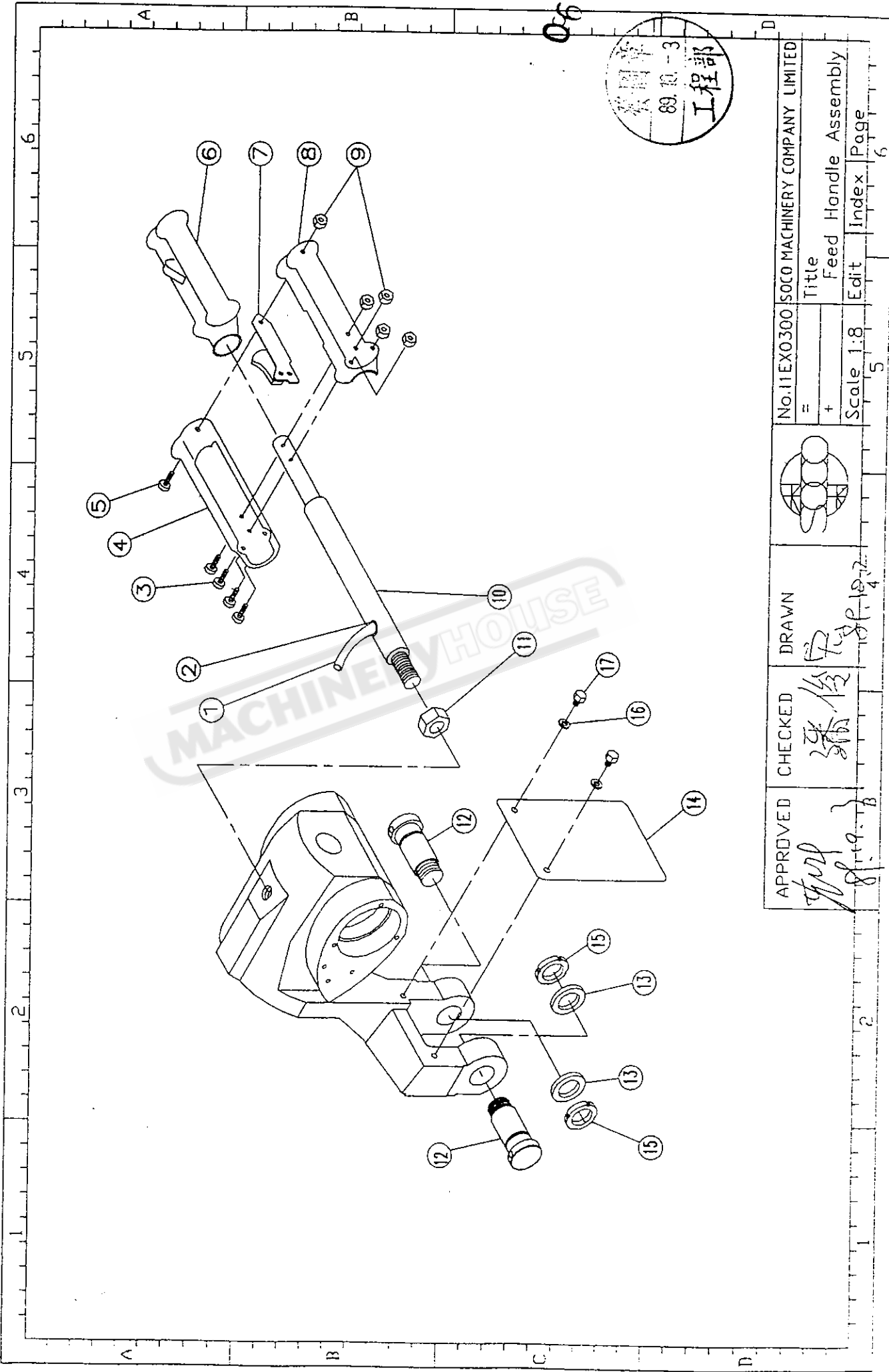

APPROVED	CHECKED	DRAWN	No.11EX0300	SOCO MACHINERY COMPANY LIMITED
<i>[Signature]</i>	<i>[Signature]</i>	<i>[Signature]</i>	=	Title
			+	Feed Handle Assembly
			Scale 1:8	Edit
				Index
				Page
				6

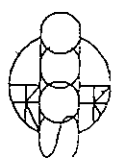

MACHINE HOUSE

\*\*\*\*\* MC-315F \*\*\*\*\*

11EX0400

NO.	PART NO.	MAT.NO.	DESCRIPTION	QT.	SPECIFICATION	NO.	PART NO.	MAT.NO.	DESCRIPTION	QT.	SPECIFICATION
1	I3D00101		WISE BODY	1	FC25	25					
2	H5D00200		BOTTOM SHIELD	1	SPCC	26					
3	H0D003		PRESS BLOCK	1	FC25	27					
4	H5D00400		PACKING-UP	1	S45C	28					06
5	F08E035		SCREW	2	M8XP1.25X35	29					
6	F06D030		SCREW	2	M6XP1.0X30	30					
7	H5D00500		PACKING-UP	1	S45C	31					
8	H0C012		PIN	2	D10X1.28	32					
9	A06D030		RIVET	2	M6xP1.0x30	33					
10	H0C012		PACKING-UP	1	S45C	34					
11	H5D00600		FIXING SCREW	1	S45C	35					
12	H0D007		SPACER	1	SS41	36					
13	M08E		HEX NUT	3	M8XP1.25	37					
14	G08E040		SCREW	3	M8XP1.25X40	38					
15	H0D008		LOCKING BLOCK	1	FC20	39					
16	H0A014		FIXING LEVER	1	SS41	40					
17	H0A029		KNOB	1	PLASTIC	41					
18	I3A00204		ROTARY SUPPORT	1	FC25	42					
19	ZK0293		GREASE NIPPLE	2	PT1/8"	43					
20	I3A007		ARM	1	SS41	44					
21	R10		SPRING WASHER	2	M10	45					
22	F10F025		SCREW	2	M10XP1.5X25	46					
23	I3F013		BRACKET	1	SS41	47					
24						48					

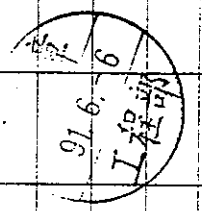



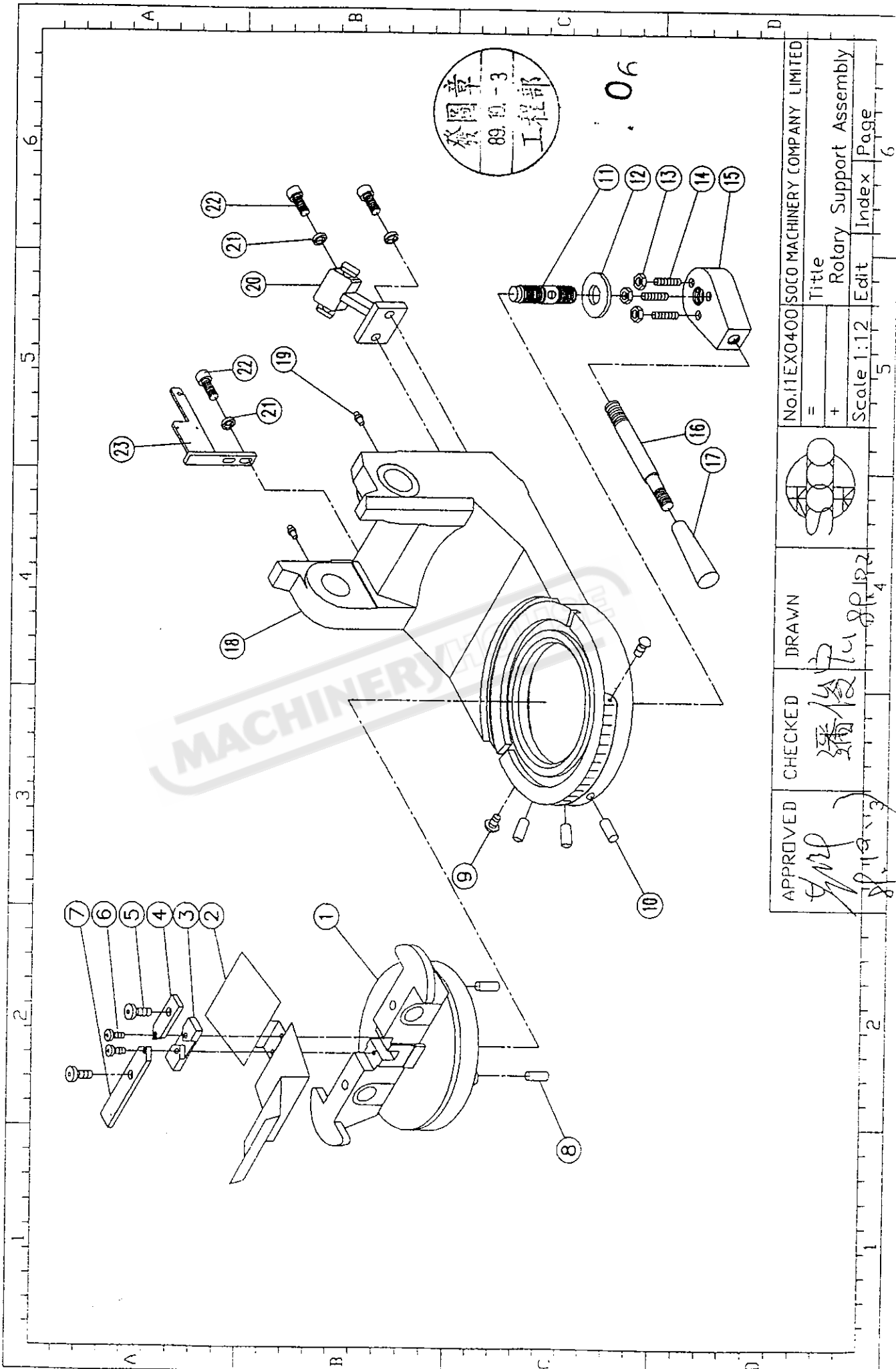

發圖章  
89.10.3  
工程組

06

APPROVED	CHECKED	DRAWN	No.11EX0400	ISOCO MACHINERY COMPANY LIMITED
<i>[Signature]</i>	<i>[Signature]</i>	<i>[Signature]</i>	=	Title
			+	Rotary Support Assembly
			Scale 1:12	Edit
			5	Index
				Page
				6

\*\*\*\*\* MC-315F \*\*\*\*\*

11EX0500

NO.	PART NO.	MAT.NO.	DESCRIPTION	QT.	SPECIFICATION	NO.	PART NO.	MAT.NO.	DESCRIPTION	QT.	SPECIFICATION
1	H5D00100		SCREW SHAFT	1	S45C	25					
2	H0D010		FRONT NUT	1	S45C	26					
3	F10F035		SCREW	4	M10XP1.5X35	27					
4	H5D00700		WISE	2	FC20	28					
5	ZQ0057		OIL SEAL	4	CV28405	29					
6	H5D00800		CLAMP KIT	2	SS41	30					
7	H5D00900		RAIL SHAFT	2	S45C	31					
8	H5D01100		CLAMP KIT	2	SS41	32					
9	H0D015		REAR NUT	1	FC25	33					
10	M10F		NUT	4	M10XP1.5	34					
11	C08E035		SCREW	2	M8XP1.25X35	35					
12	H0A017		RULLER FINGER	1	SUS304	36					
13	B03A005		SCREW	2	M3XP0.5X5	37					
14	H0D016		HANDLE SOCKET	1	FC25	38					
15	ZK0200		SPRING PIN	1	D6X40	39					
16	M12G		NUT	3	M12XP1.75	40					
17	H0D017		CLAMP LEVER	3	SS41	41					
18	ZK0033		KNOB	3	1/2" BALL	42					
19						43					
20						44					
21						45					
22						46					
23						47					
24						48					

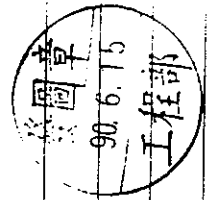

06

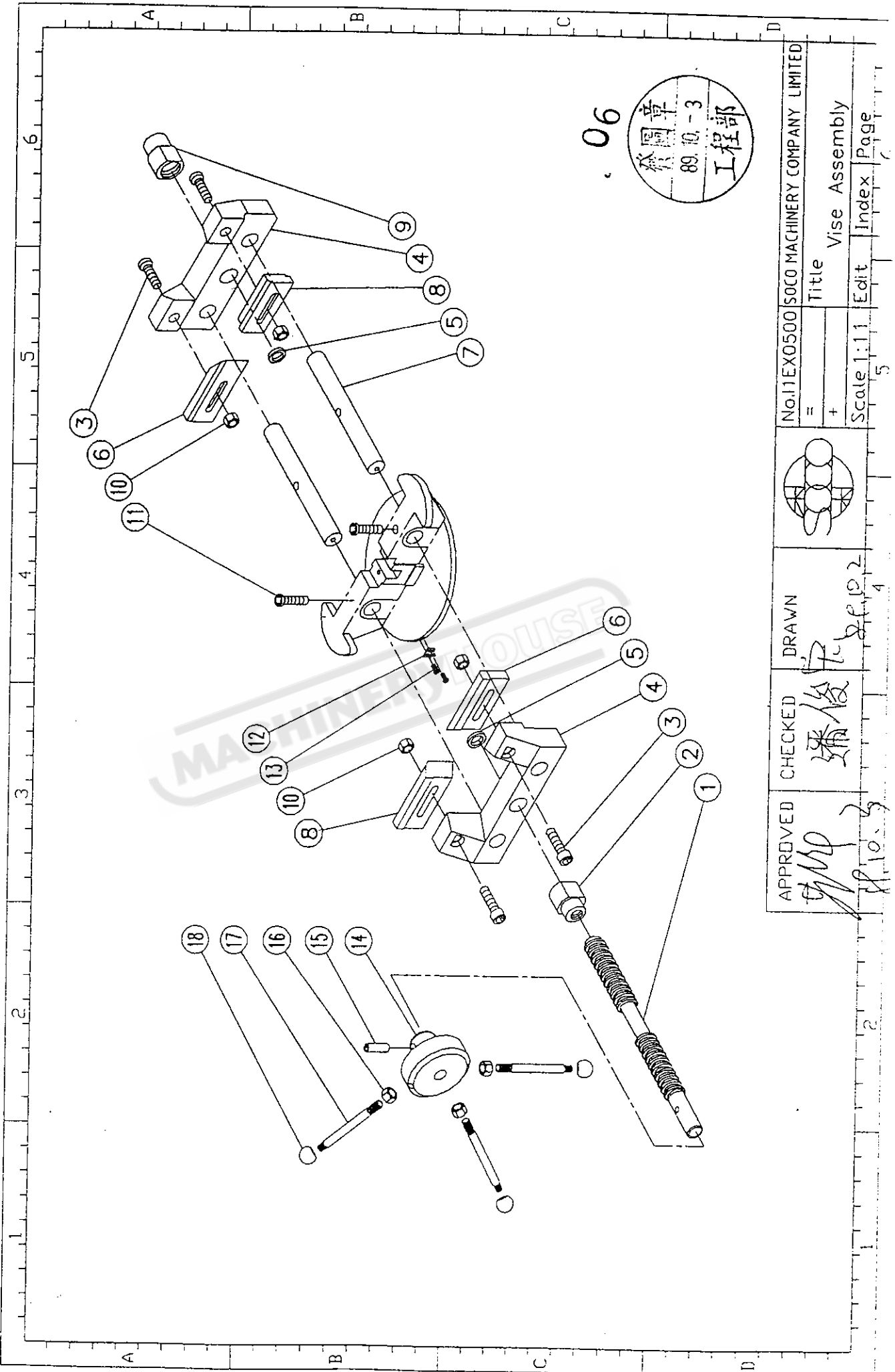

06  
 發圖章  
 89.10.-3  
 工程部

MACHINE HOUSE

APPROVED <i>[Signature]</i> 8.10.3	CHECKED <i>[Signature]</i>	DRAWN <i>[Signature]</i> 8.10.2		No.11EX0500 SOCO MACHINERY COMPANY LIMITED	
				Title	Vise Assembly
Scale 1:1.1			Edit	Index	Page
			5		11

\*\*\*\*\* MC-315F \*\*\*\*\*

NO.	PART NO.	MAT.NO.	DESCRIPTION	QTY.	SPECIFICATION	NO.	PART NO.	MAT.NO.	DESCRIPTION	QTY.	SPECIFICATION
1	H5A00200		TABLE	1	FC20	25					
2	I3A01601		LOCKING PLATE	1	S45C	26					
3	ZK0275		PIN	1	D10XL30	27					
4	I3A01501		ANGLE FIXING ASS'Y BODY	1	FC25	28					
5	Q08		FLAT WASHER	2	M8	29					
6	M08E055		SCREW	2	M8XP1.25X55	30					
7	H5A00600		OIL FILTER	1	MESHES	31					
8	H0A021		WASHER	3	S45C	32					
9	R10		SPRING WASHER	3	M10	33					
10	E10F050		SCREW	3	M10XP1.5X50	34					
11	M08E		HEX NUT	1	M8	35					
12	F08E030		SCREW	1	M8XP1.25X30	36					
13	ZK0023		HOOK	4	12M/M	37					
14											
15											
16											
17											
18											
19											
20											
21											
22											
23											
24											

06

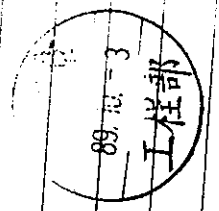

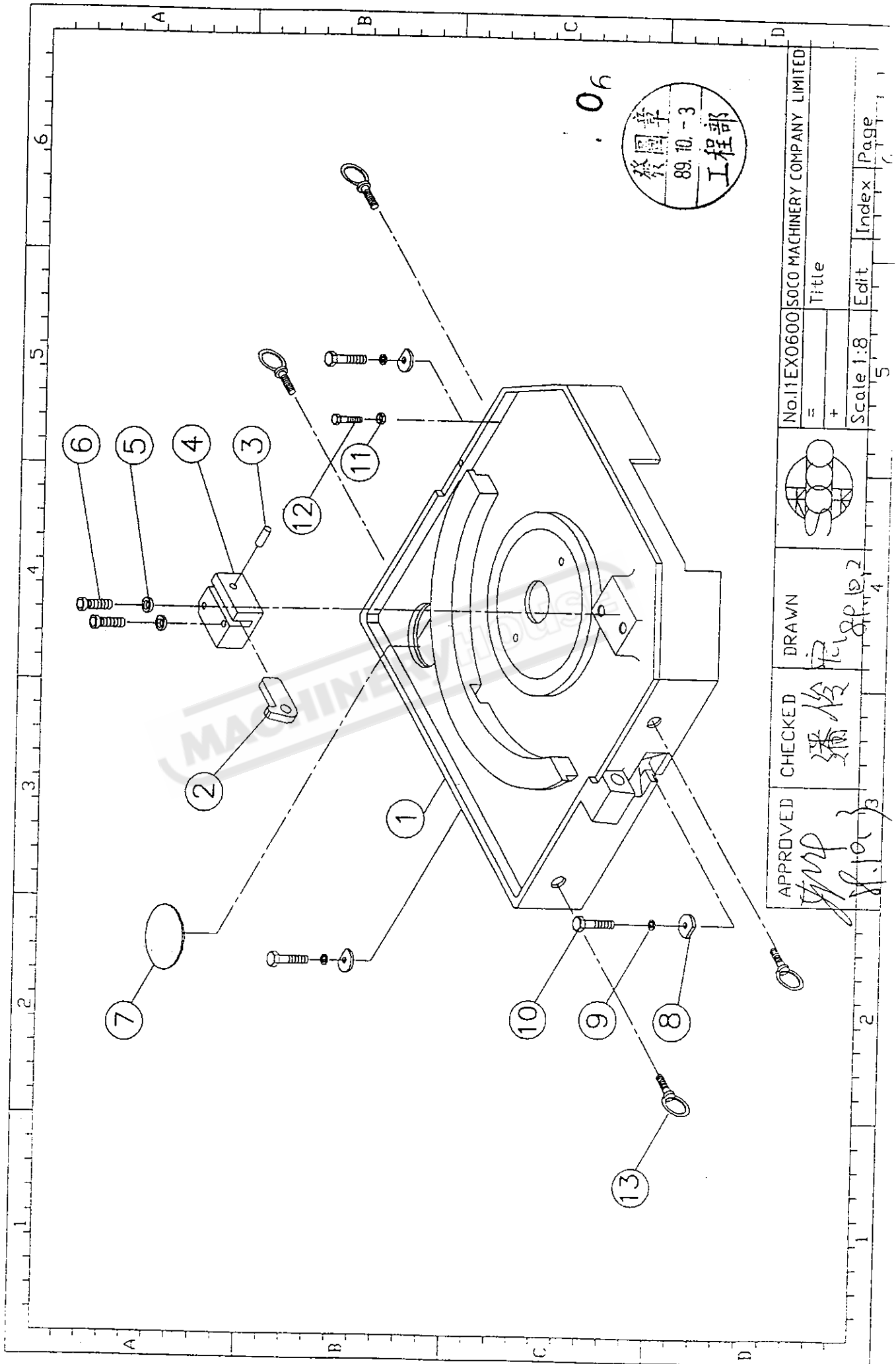

APPROVED	CHECKED	DRAWN	No. I1EX0600	SOCO MACHINERY COMPANY LIMITED	
				=	+
潘俊 (Pan Jun) 89.10.27			Title		
89.10.27			Scale 1:8		
89.10.27			Edit		
89.10.27			Index		
89.10.27			Page		
89.10.27			5		

\*\*\*\*\* MC-315F \*\*\*\*\*

11EX0700

NO.	PART NO.	MAT.NO.	DESCRIPTION	QT.	SPECIFICATION	NO.	PART NO.	MAT.NO.	DESCRIPTION	QT.	SPECIFICATION
1	I3F01904		SAFETY GUARD	1	FC25	25	ZK0289		STEEL WHEEL	1	φ 38
2	M08E		NUT	1	M8XP1.25	26	ZP0017		C RING	1	S-10
3	IC0058		WATER HOSE	1	3/8" - 150cm	27	I3F02000		ADJUST BAR	1	SS41
4	ZR0016		HORSE CLAMPER	1	15mm	28	I3F02101		COVER	1	SS41
5	IB0150		CONTROL VALVE	1	PT1/8" - W3/8"	29					
6	GK0190		ELBOW	1	M8-PT1/8" - 90°	30					
7	I3F00101		SHIELD	1	AC4C	31					
8	I3F004		SCREW	1	SS41	32					
9	M10F		HEX NUT	2	M10	33					
10	F10F016		SCREW	2	M10XP1.5X16	34					
11	Q10F		SPRING WASHER	2	M10	35					
12	I3F016		LEVER	1	SPCC	36					
13	I3F017		LEVER	1	SPCC	37					
14	F10F020		SCREW	2	M10XP1.5X20	38					
15	I3F018		LEVER	1	STEEL ROPE	39					
16	F06D016		SCREW	3	M6XP1.0X16	40					
17	F08E030		SCREW	2	M8XP1.25X30	41					
18	M05C		HEX NUT	1	M5XP0.8	42					
19	F05C016		SCREW	1	M5XP0.8X16	43					
20	F06D020		SCREW	2	M6XP1.0X20	44					
21	Q06		FLAT WASHER	2	M6	45					
22	R08		SPRING WASHER	2	M8	46					
23	Q08		FLAT WASHER	2	M8	47					
24	ZK0275		PIN	1	φ 10X30L	48					

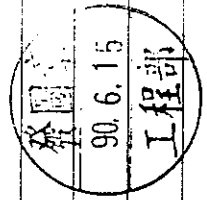

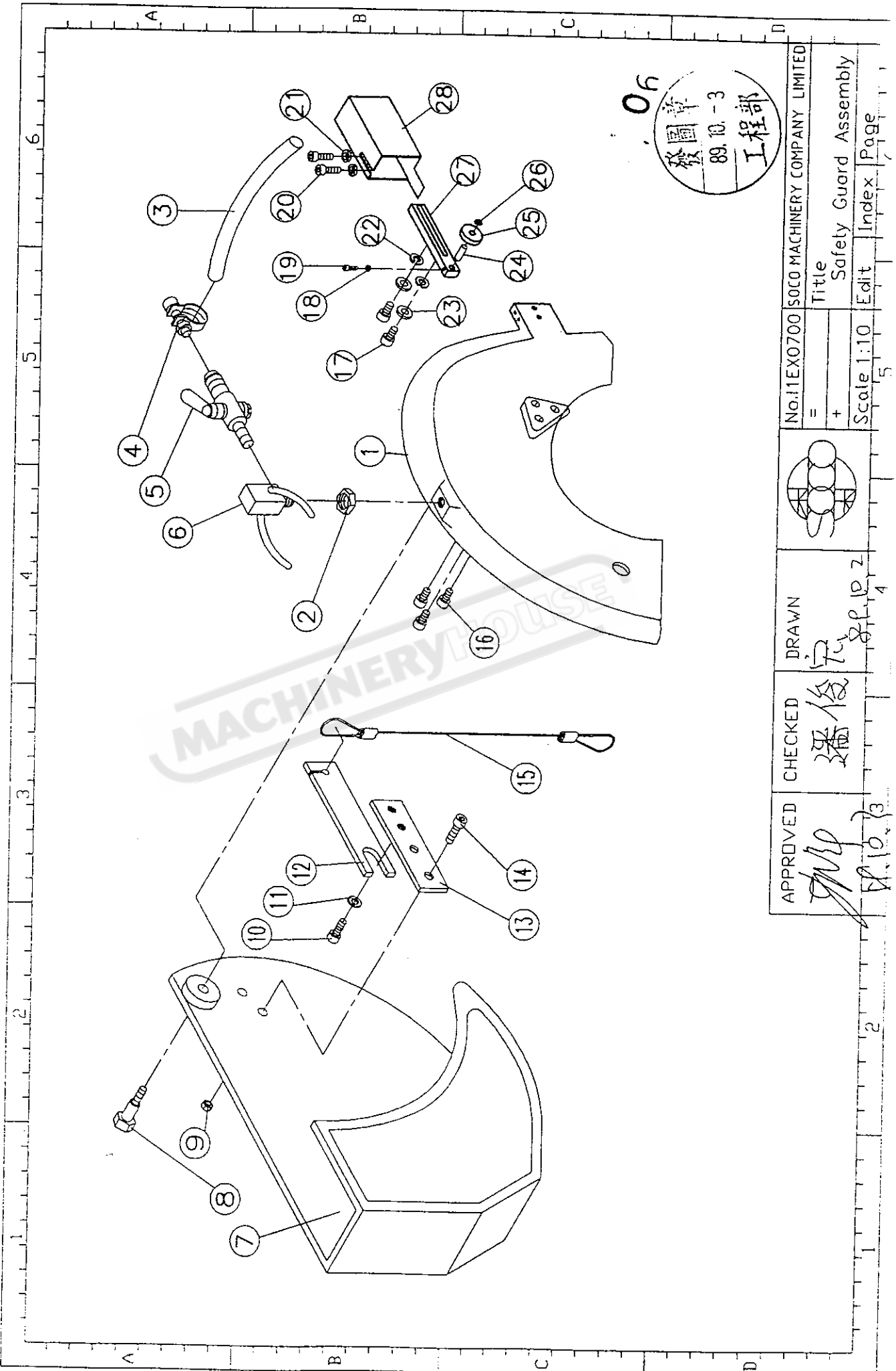

06  
 發圖章  
 89.10.-3  
 工程部

MACHINERY ENGINEERING

APPROVED	CHECKED	DRAWN	No.11EX0700	SOCO MACHINERY COMPANY LIMITED
<i>[Signature]</i>	潘俊	潘俊	=	Title
			+	Safety Guard Assembly
			Scale 1:10	Edit
			5	Index
				Page
				1

NO.	PART NO.	MAT.NO.	DESCRIPTION	QT.	SPECIFICATION	NO.	PART NO.	MAT.NO.	DESCRIPTION	QT.	SPECIFICATION
1	H5H00200		BASE	1	SPCC	25					
2	H0H002		ELECTRIC BOX	1	SS41	26					
3	Q05		FLAT WASHER	4	M5	27					
4	B05C010		SCREW	4	M5XPO.8X10	28					
5	WS0068		MAGNETIC CONTACTOR	1	CN-16, AC24V	29					
6	WA0034		TRANSFORMER	1	220,380,415,440V/19,24V,40V A	30					
7	H0H003		LID	1	SS41	31					
8	ZR0020		CLAMPER	2	7C	32					
9	ZR0019		CLAMPER	1	4C	33					
10	ZG0028		QUICK JOINT	2	SPL6-01	34					
11	E06D025		SCREW	8	M6XP1.0X25	35					
12	IC0236		PU HOSE	1	4X6	36					
13	F08E025		SCREW	2	M8XP1.25X25	37					
14	IC0058		WATER HOSE	1	3/8"-150mm	38					
15	ZR0017		HOSE CLAMPER	1	15mm	39					
16	ZA0010		JOINT COPPER	1	3/8IN-3/8OUT	40					
17	YB0019		CHECK VALVE	1	PT3/8	41					
18	ZN0031		JOINT	1	PT3/8OUT-PT3/8IN						
19	YF0015		PUMP	1	1/8HP-150L						
20	XA0061		CABLE	1	4CX0.75mm-700L						
21			OVER RELAY	1							
22											
23											
24											

06

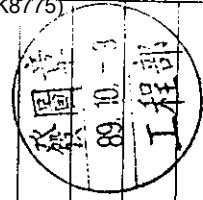

3/1.5HP  
 220V RHN-10M(8.5~12.5)  
 380V RHN-10M(5.5~8.5)  
 415V RHN-10M(5.5~8.5)  
 440V RHN-10M(3.5~5)  
 1.4/1HP  
 RHN-10M(5.5~8.5)  
 RHN-10M(3.5~5)  
 RHN-10M(3.5~5)



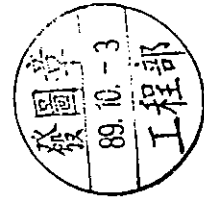
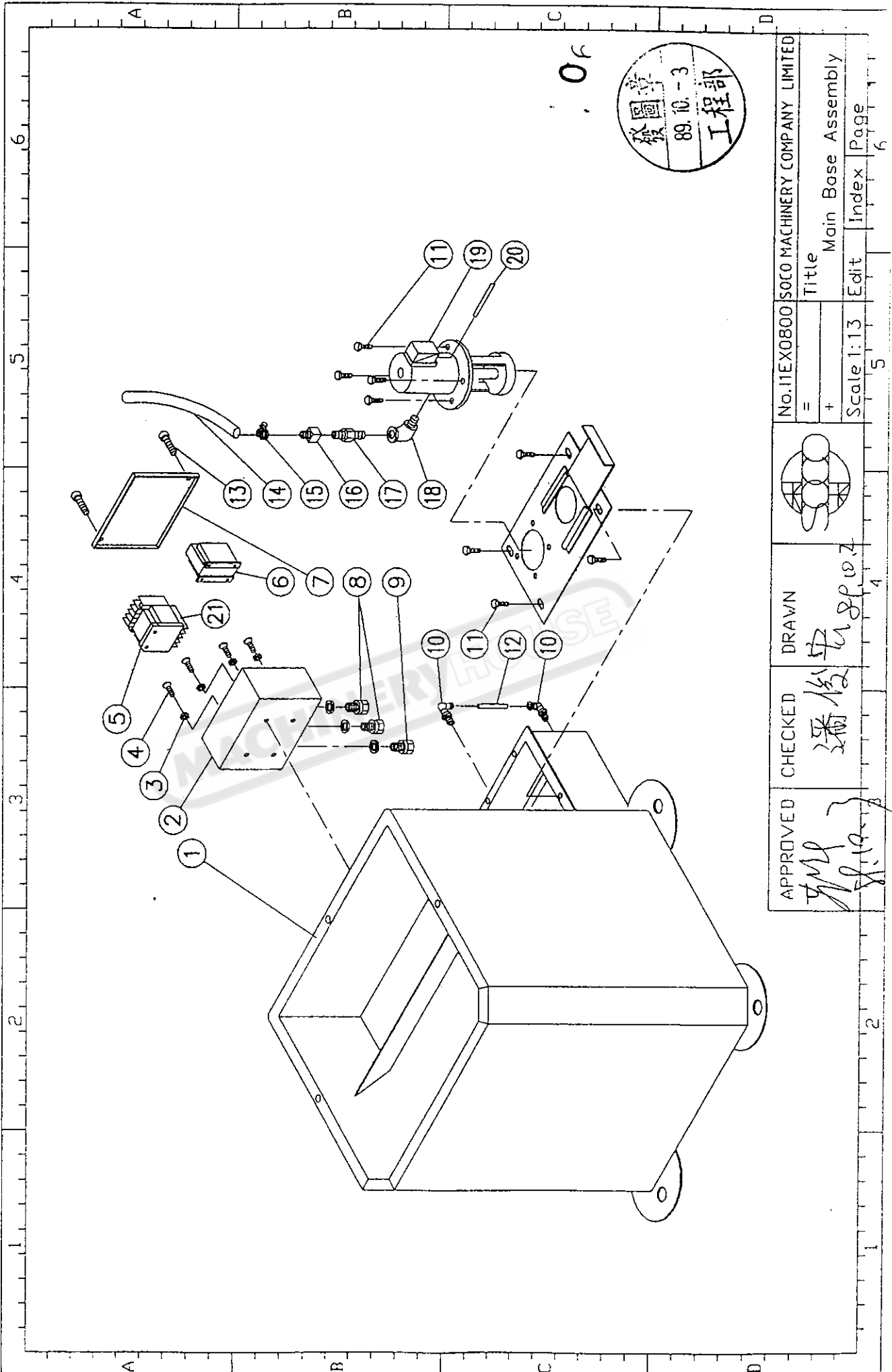

APPROVED	CHECKED	DRAWN	No.11EX0800	SOCO MACHINERY COMPANY LIMITED
			=	Title
[Signature]	[Signature]	[Signature]	+	Main Base Assembly
			Scale 1:13	Edit
			5	Page
				Index
				6